

RLM E Series(Airfoil blades)

Professional HVAC Fan & Motors Manufacturer

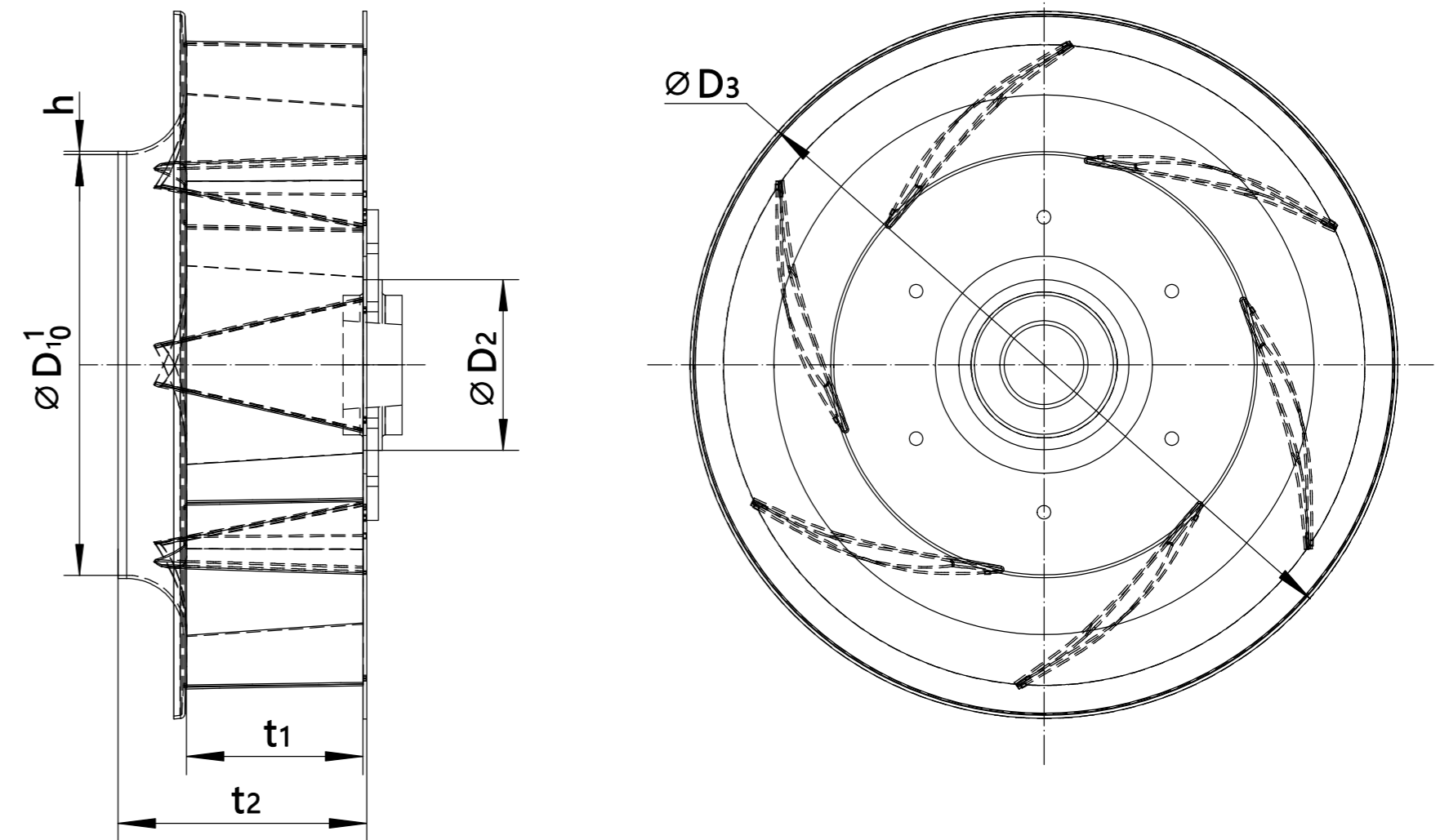

RLM E Series(Airfoil blades)



Technical Specifications

Model	D1	D2	D3	t1	t2
RLM E-280	189	90	323	82	114.8
RLM E-315	215	90	360	90	126.65
RLM E-355	241.5	90	406	100.5	142.05
RLM E-400	271	110	456	113.5	160
RLM E-450	304	110	512	127.8	180.5
RLM E-500	337	110	570	142	200
RLM E-560	337.4	140	640	160	225.6
RLM E-630	424.6	140	720	180	253.3
RLM E-710	478	170	810	202	284.1
RLM E-800	539.2	170	912	229	321
RLM E-900	606	190	1023	255	359
RLM E-1000	674	220	1120	285.91	401

RLM E-280

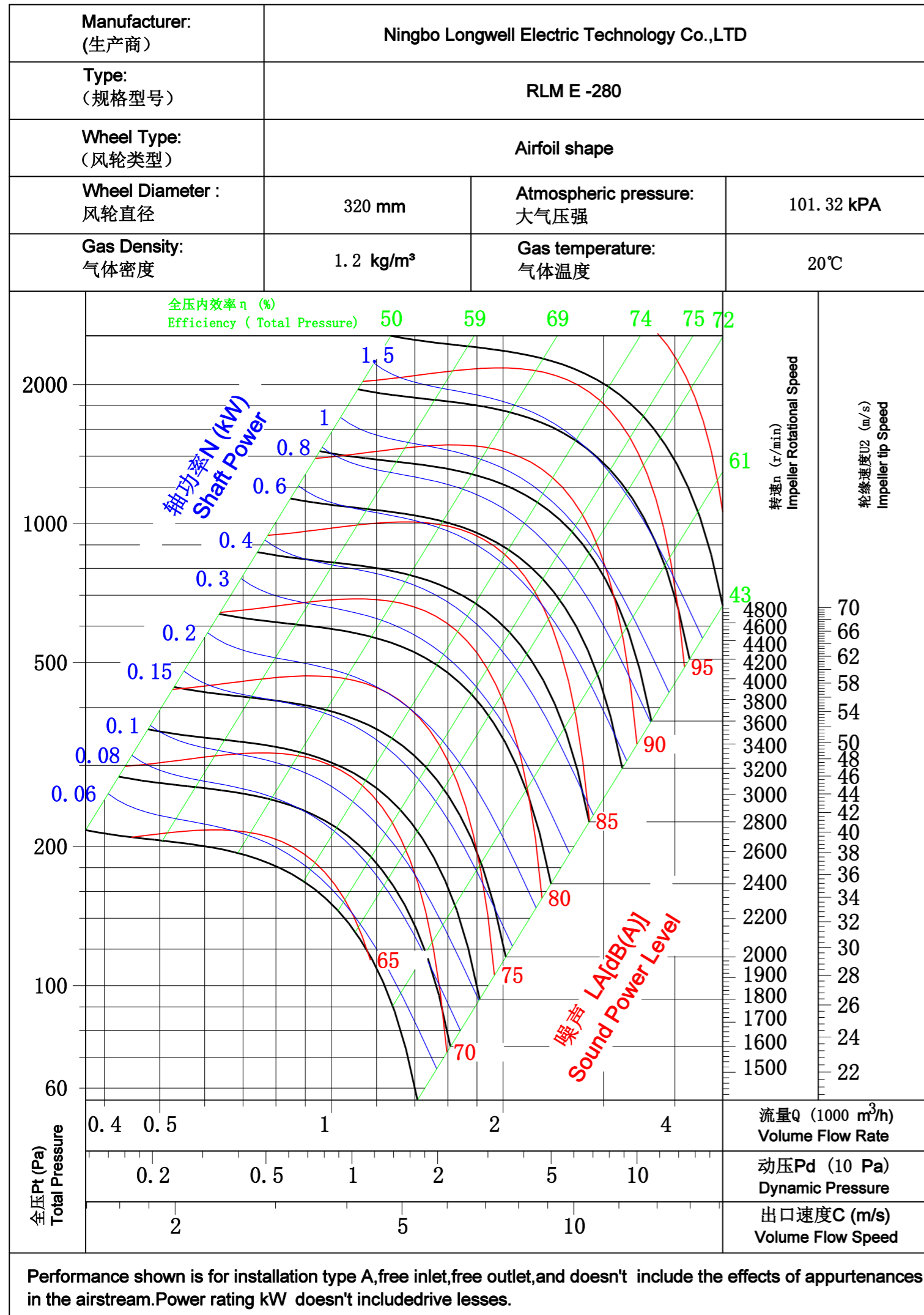

RLM E-315

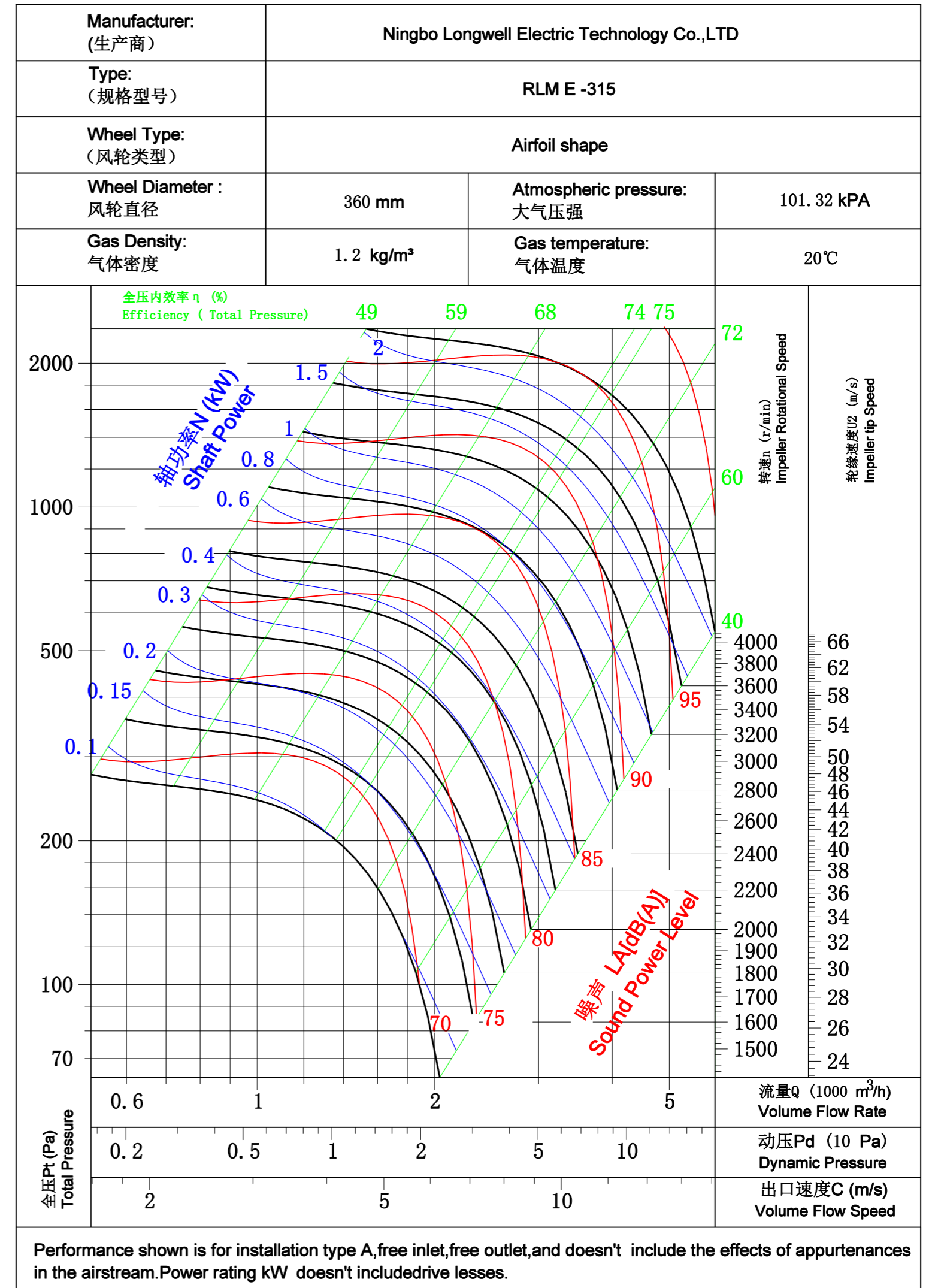

RLM E-355

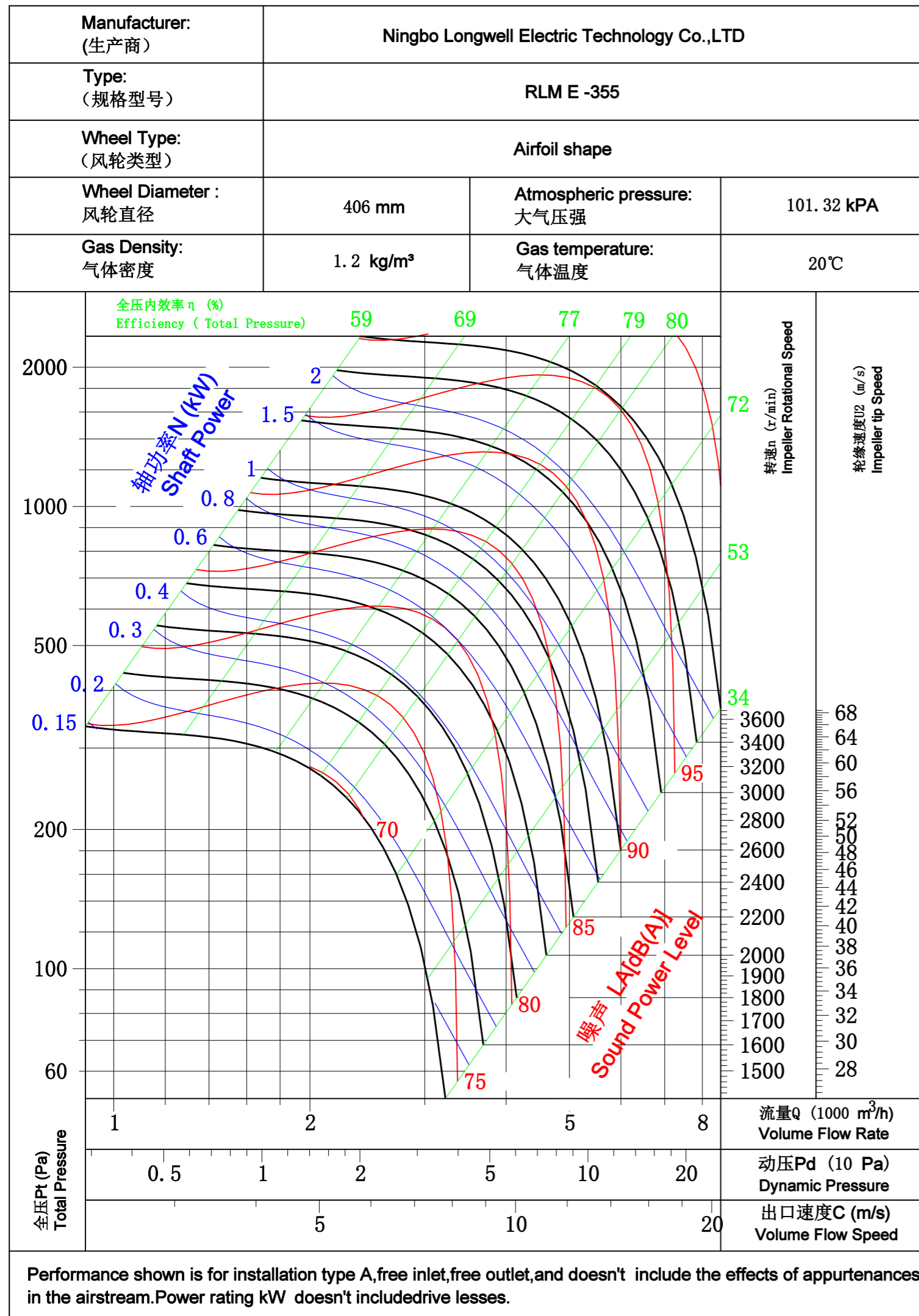

RLM E-400

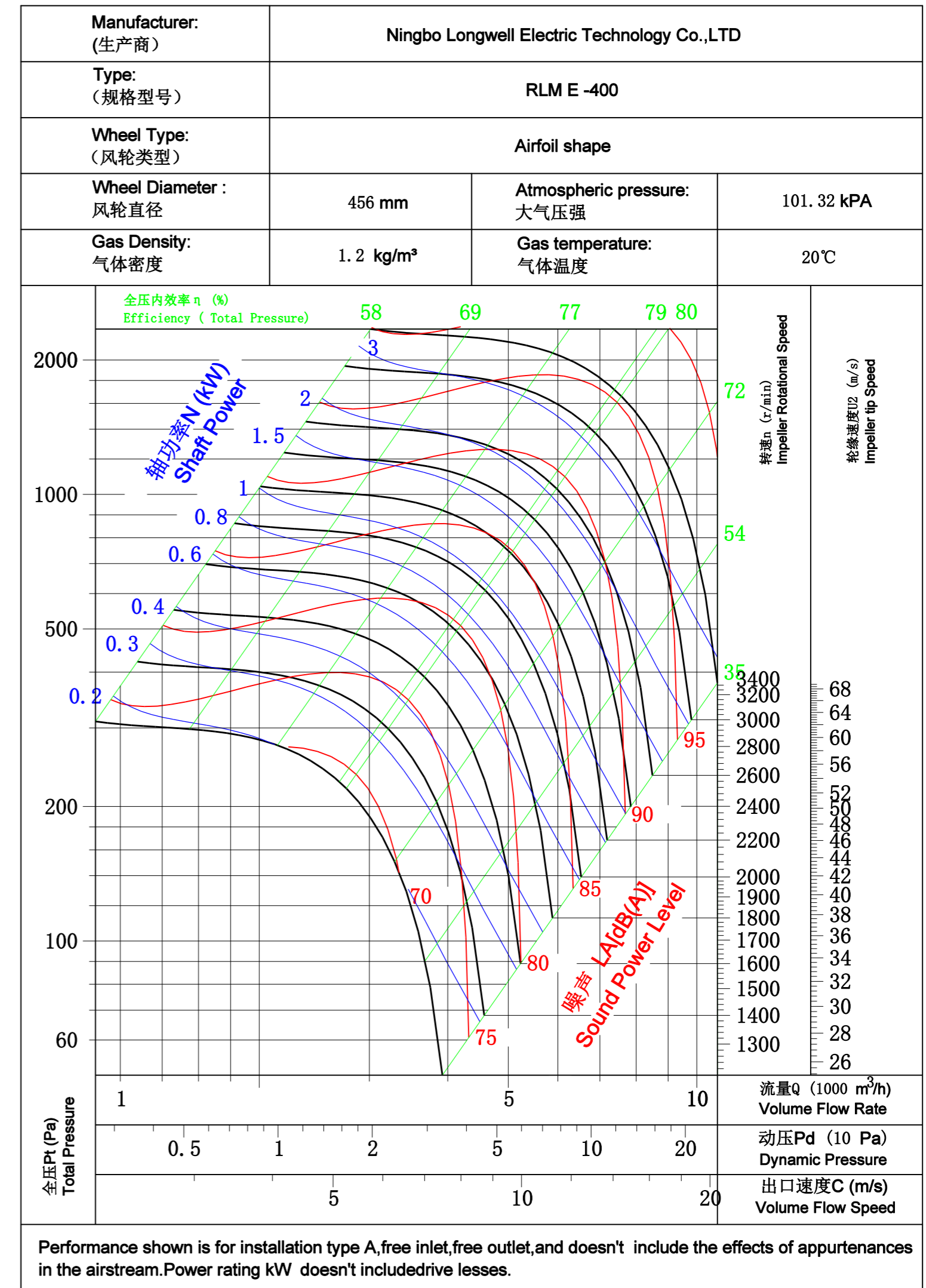

RLM E-450

Manufacturer: (生产商)	Ningbo Longwell Electric Technology Co.,LTD		
Type: (规格型号)	RLM E -450		
Wheel Type: (风轮类型)	Airfoil shape		
Wheel Diameter : 风轮直径	512 mm	Atmospheric pressure: 大气压强	101.32 kPa
Gas Density: 气体密度	1.2 kg/m ³	Gas temperature: 气体温度	20℃

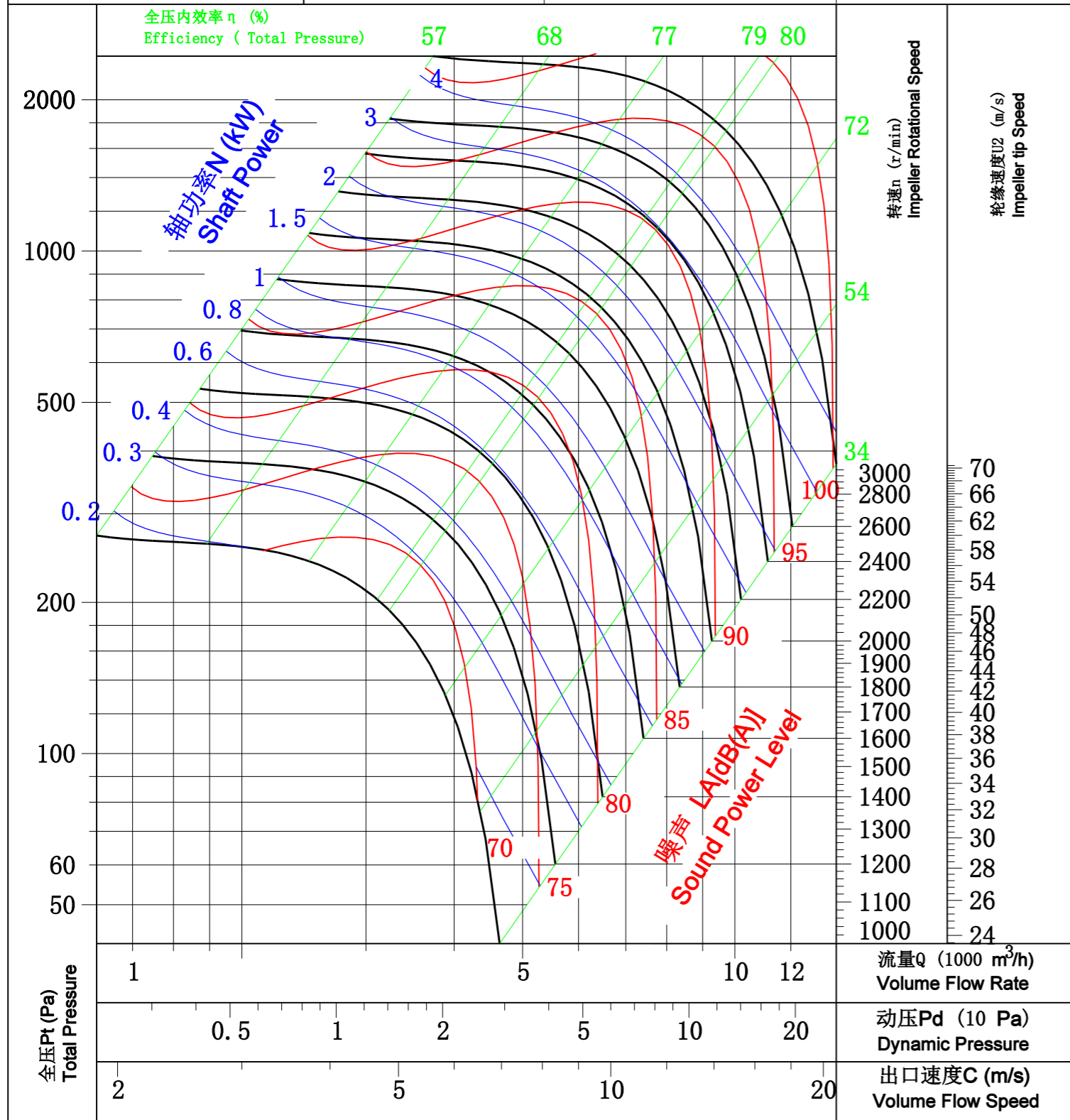

Performance shown is for installation type A, free inlet, free outlet, and doesn't include the effects of appurtenances in the airstream. Power rating kW doesn't include drive losses.

RLM E-500

Manufacturer: (生产商)	Ningbo Longwell Electric Technology Co.,LTD		
Type: (规格型号)	RLM E -500		
Wheel Type: (风轮类型)	Airfoil shape		
Wheel Diameter : 风轮直径	570 mm	Atmospheric pressure: 大气压强	101.32 kPa
Gas Density: 气体密度	1.2 kg/m ³	Gas temperature: 气体温度	20℃

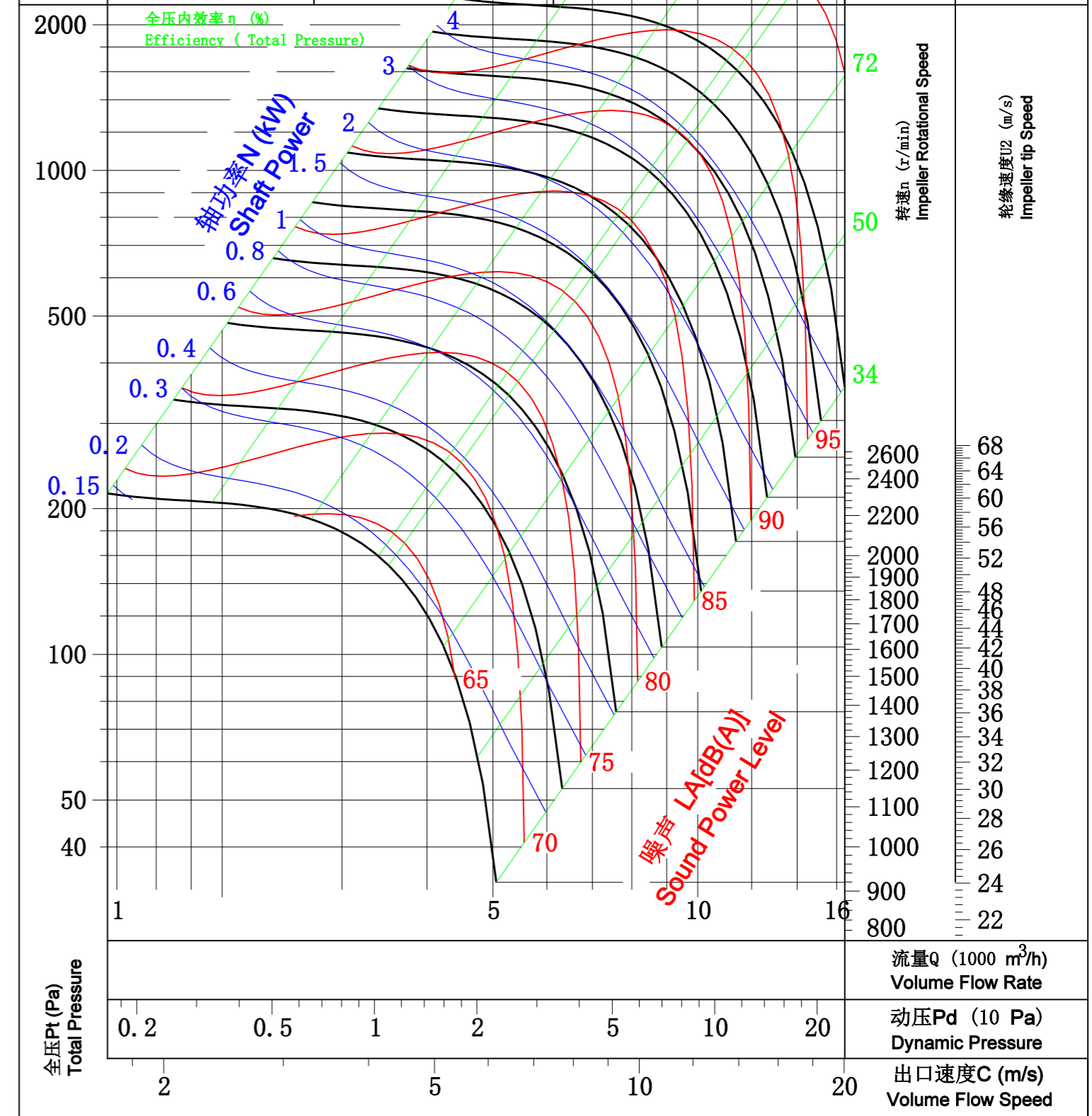

Performance shown is for installation type A, free inlet, free outlet, and doesn't include the effects of appurtenances in the airstream. Power rating kW doesn't include drive losses.

RLM E-560

Manufacturer: (生产商)	Ningbo Longwell Electric Technology Co.,LTD		
Type: (规格型号)	RLM E -560		
Wheel Type: (风轮类型)	Airfoil shape		
Wheel Diameter : 风轮直径	640 mm	Atmospheric pressure: 大气压强	101.32 kPa
Gas Density: 气体密度	1.2 kg/m³	Gas temperature: 气体温度	20°C

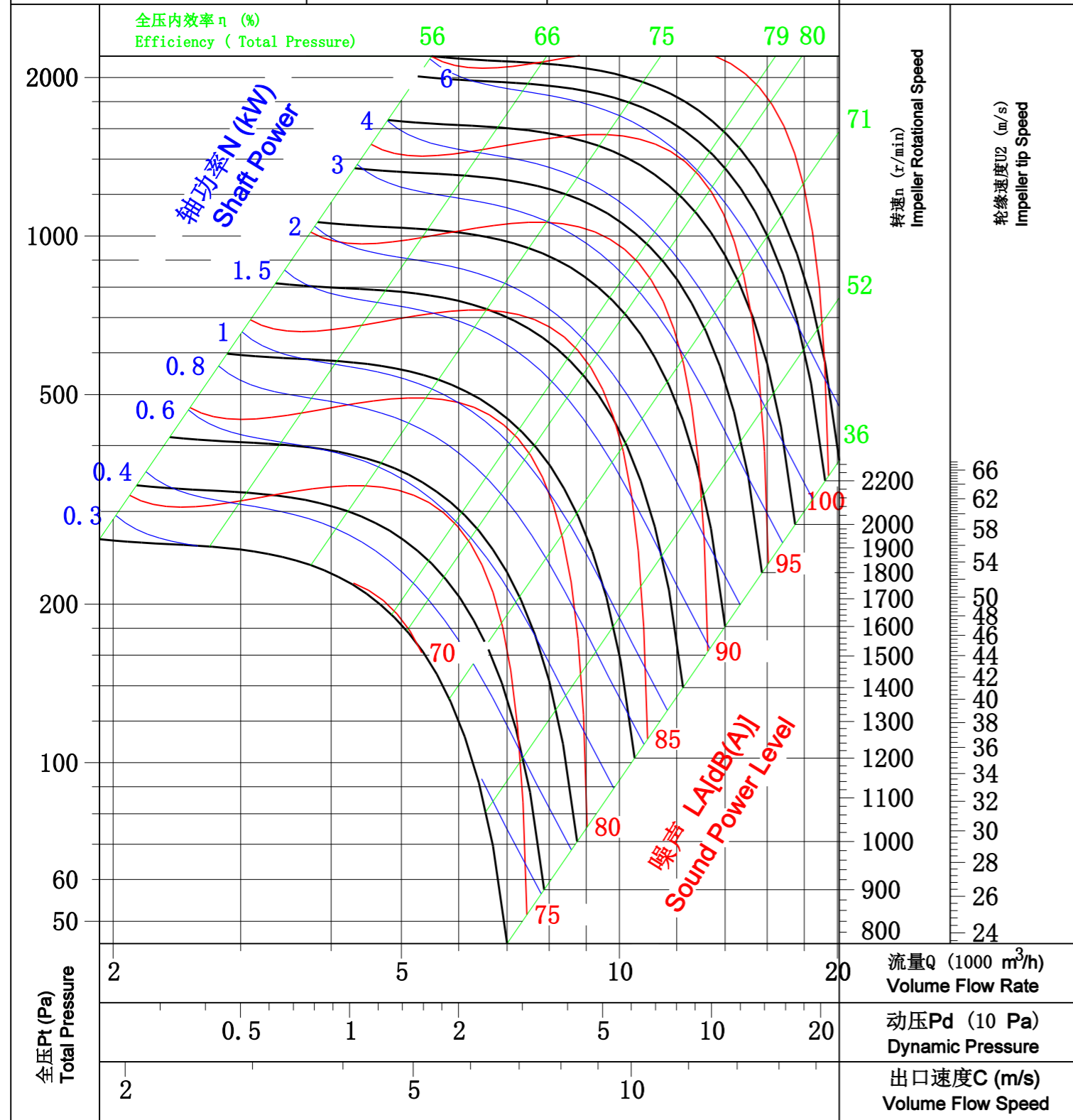

Performance shown is for installation type A, free inlet, free outlet, and doesn't include the effects of appurtenances in the airstream. Power rating kW doesn't include drive losses.

RLM E-630

Manufacturer: (生产商)	Ningbo Longwell Electric Technology Co.,LTD		
Type: (规格型号)	RLM E -630		
Wheel Type: (风轮类型)	Airfoil shape		
Wheel Diameter : 风轮直径	720 mm	Atmospheric pressure: 大气压强	101.32 kPa
Gas Density: 气体密度	1.2 kg/m³	Gas temperature: 气体温度	20°C

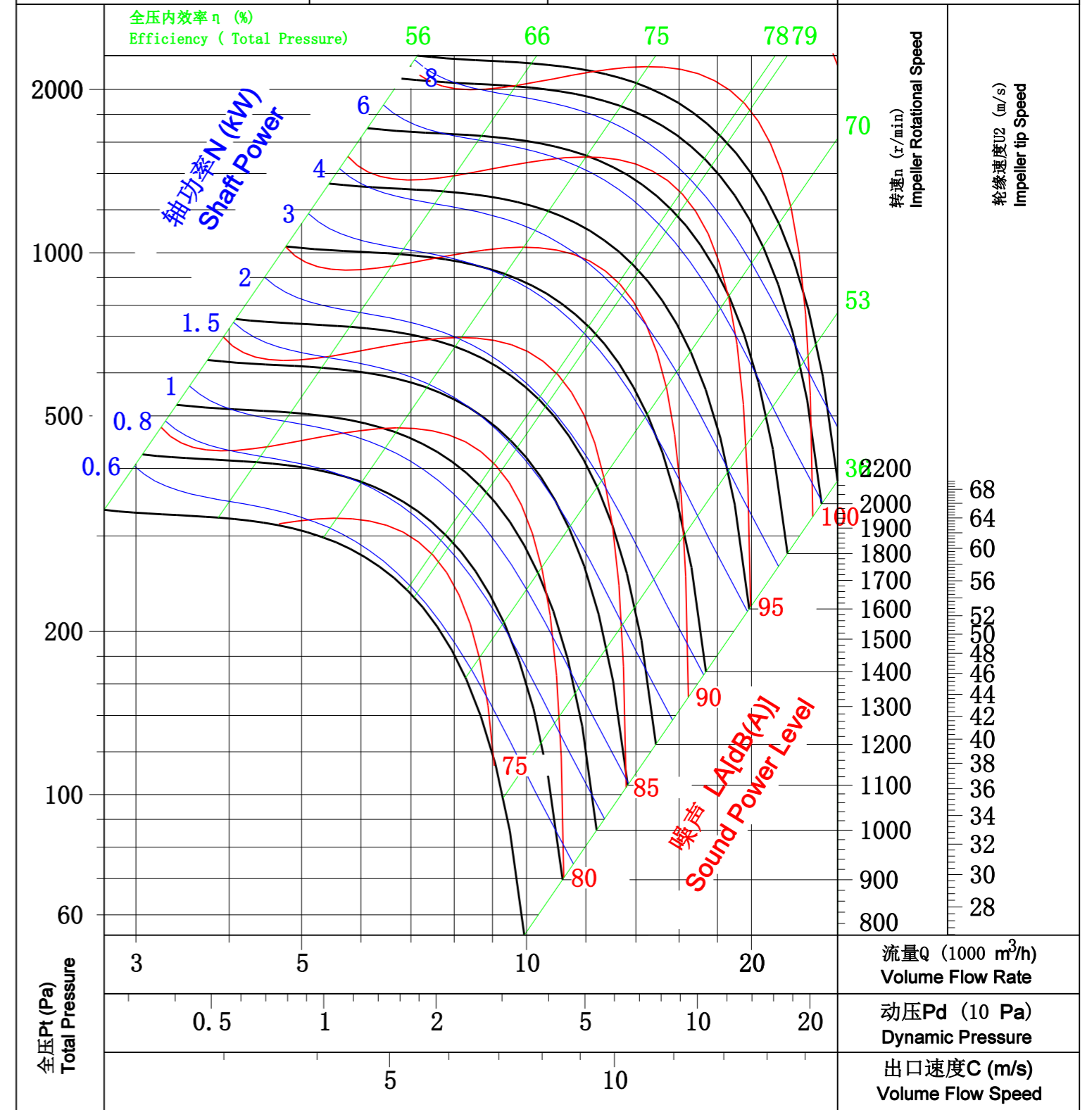

Performance shown is for installation type A, free inlet, free outlet, and doesn't include the effects of appurtenances in the airstream. Power rating kW doesn't include drive losses.

RLM E-710

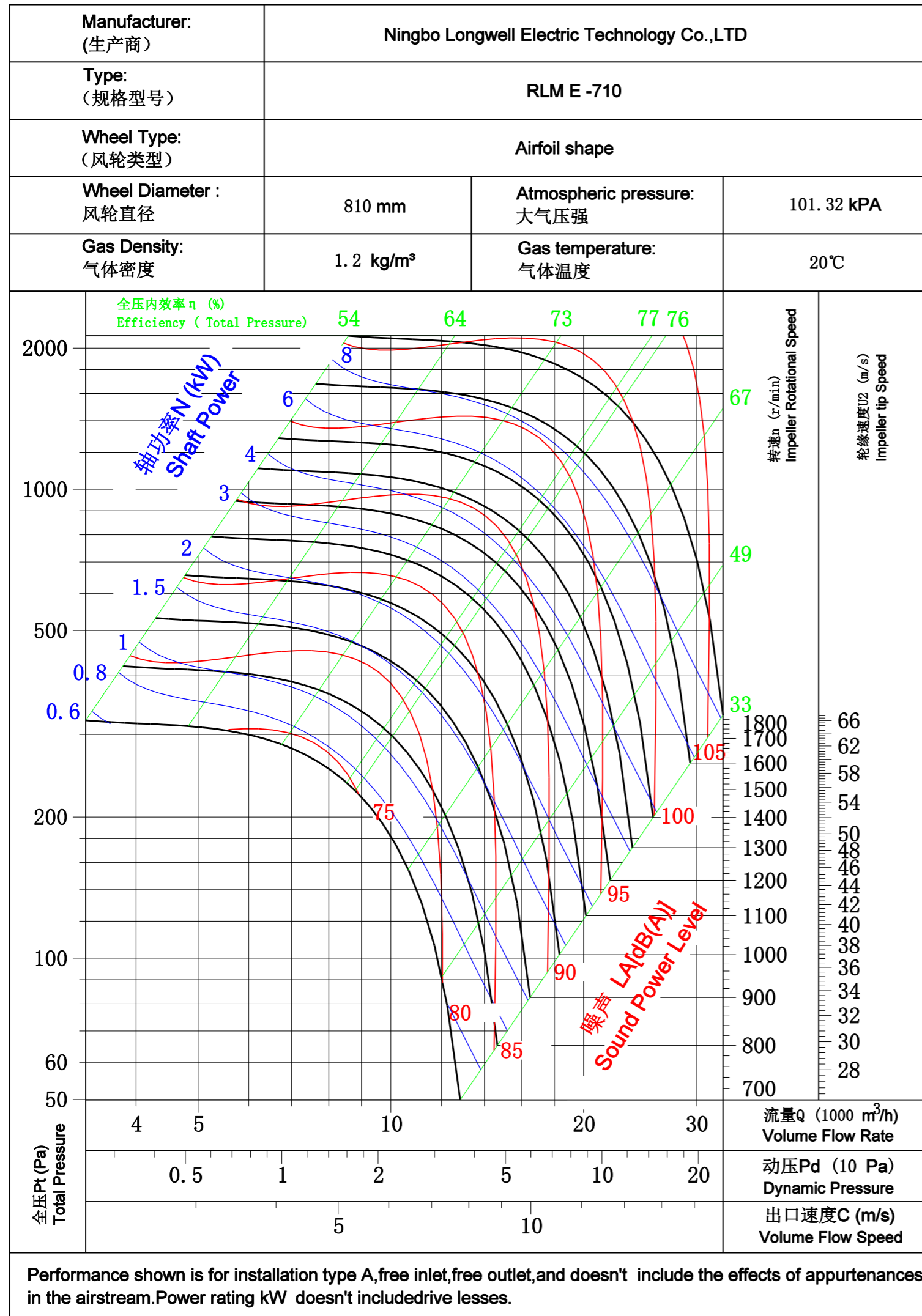

RLM E-800

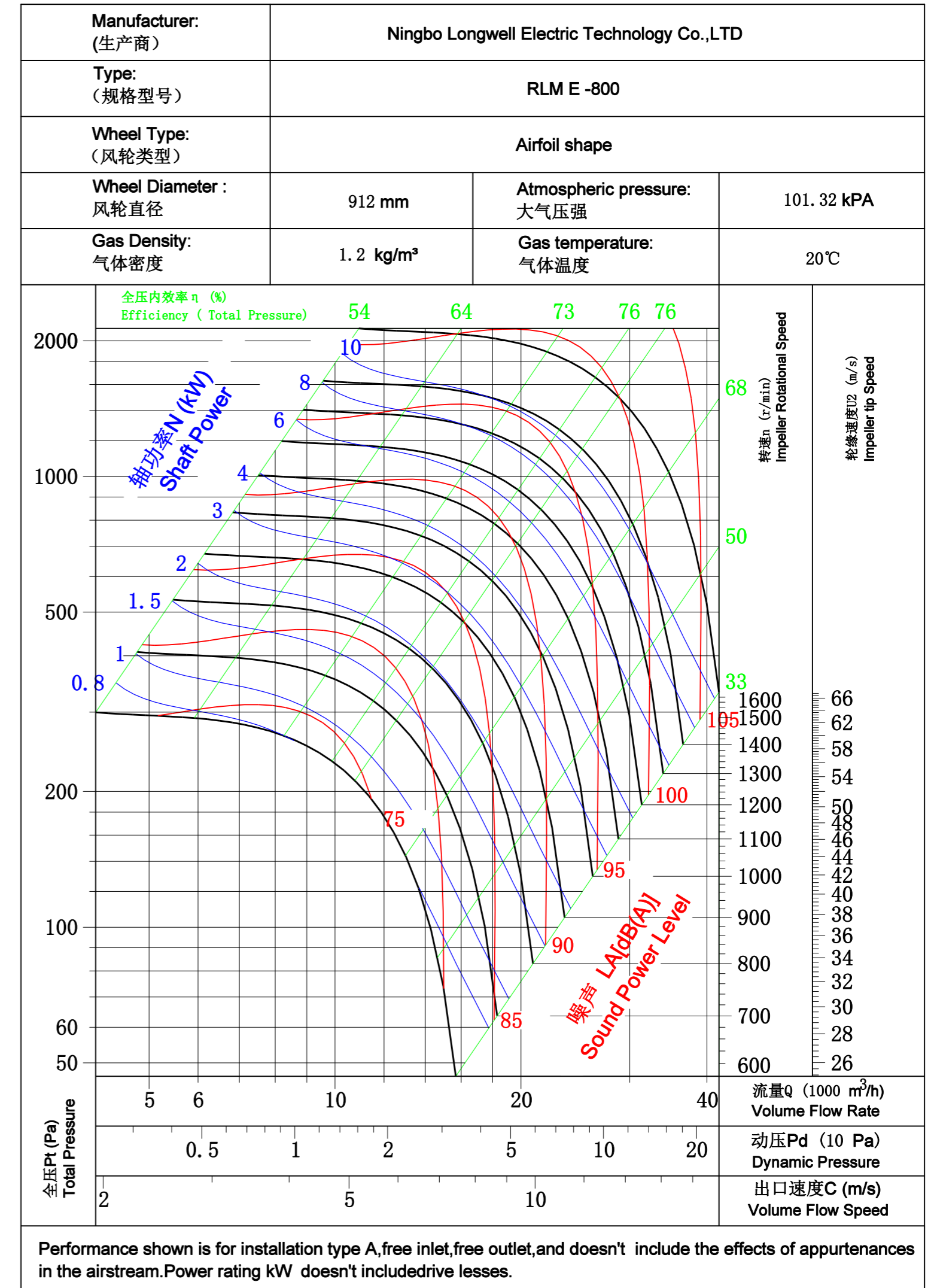

RLM E-900

Manufacturer: (生产商)	Ningbo Longwell Electric Technology Co.,LTD		
Type: (规格型号)	RLM E -900		
Wheel Type: (风轮类型)	Airfoil shape		
Wheel Diameter : 风轮直径	1023 mm	Atmospheric pressure: 大气压强	101.32 kPa
Gas Density: 气体密度	1.2 kg/m³	Gas temperature: 气体温度	20℃

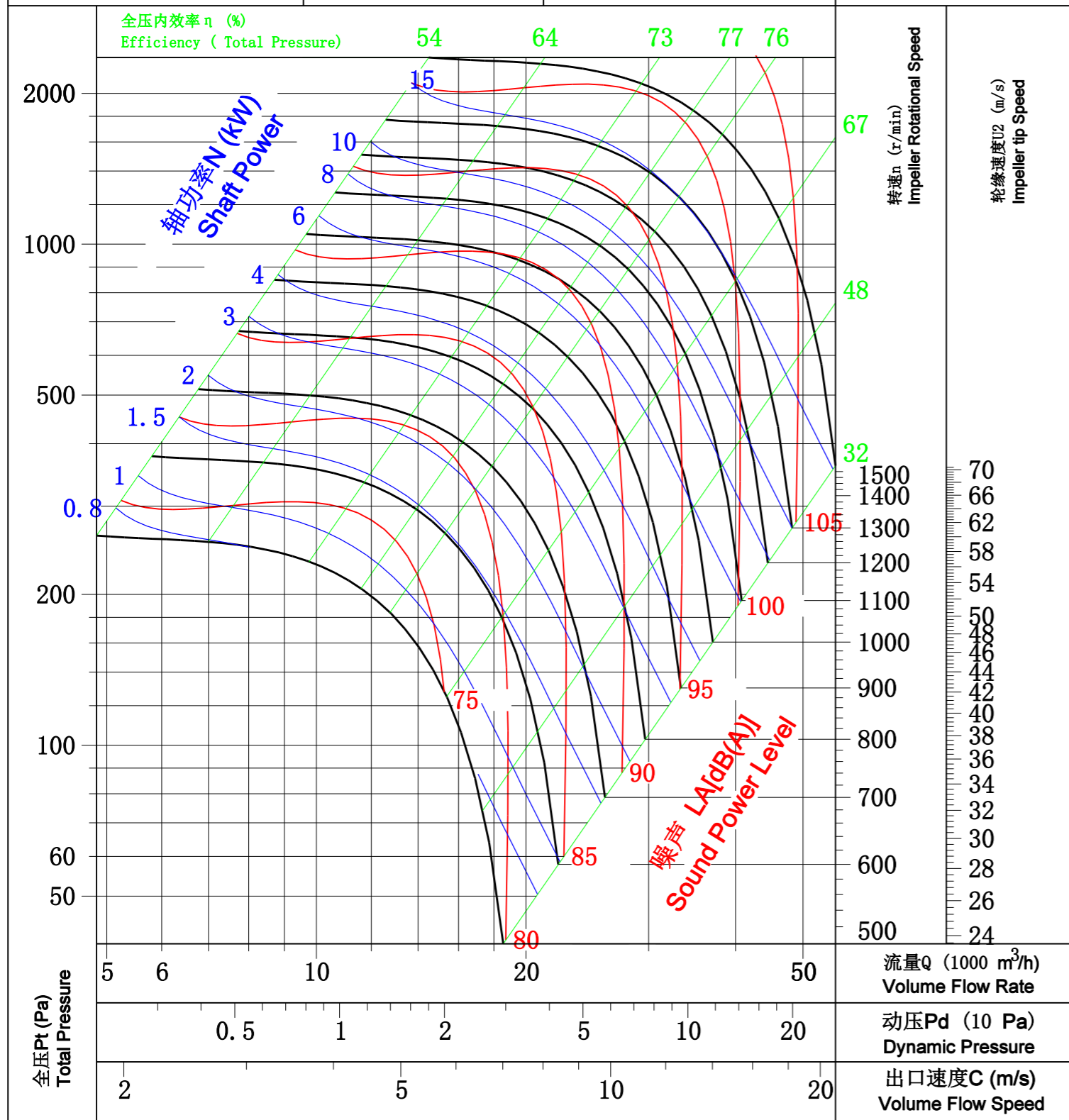

Performance shown is for installation type A, free inlet, free outlet, and doesn't include the effects of appurtenances in the airstream. Power rating kW doesn't include drive losses.

RLM E-1000

Manufacturer: (生产商)	Ningbo Longwell Electric Technology Co.,LTD		
Type: (规格型号)	RLM E -1000		
Wheel Type: (风轮类型)	Airfoil shape		
Wheel Diameter : 风轮直径	1120 mm	Atmospheric pressure: 大气压强	101.32 kPa
Gas Density: 气体密度	1.2 kg/m³	Gas temperature: 气体温度	20℃

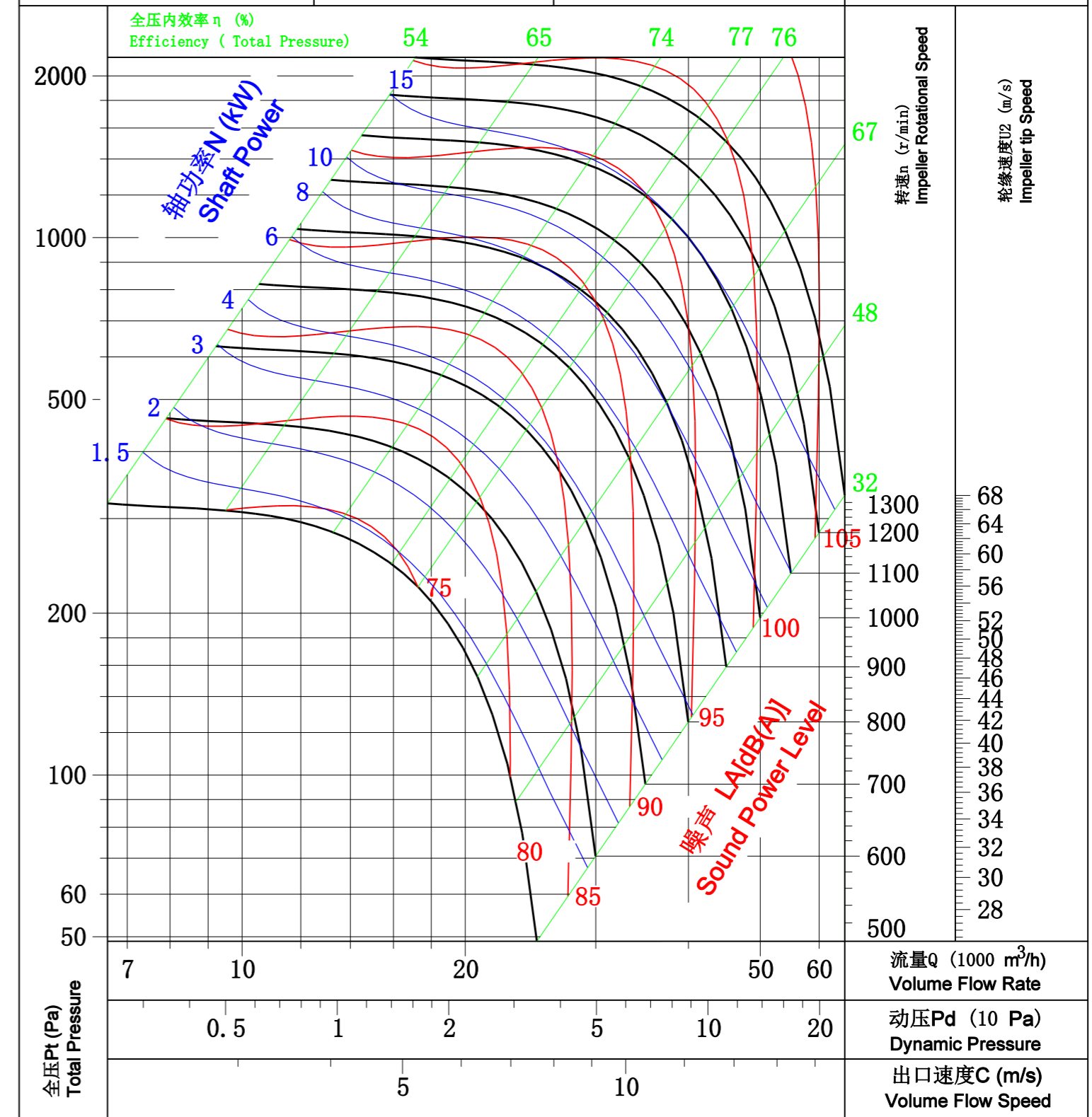

Performance shown is for installation type A, free inlet, free outlet, and doesn't include the effects of appurtenances in the airstream. Power rating kW doesn't include drive losses.