

# ***RLM Series Centrifugal Blower***

Professional HVAC Fan & Motors Manufacturer



## PLUG FAN-RLM Series

### Impeller

Centrifugal plug fan impellers are made of sheet steel with backward blade, according aerodynamics design the impeller have high efficiency and low power.

Maximum tip speed of the impeller is 70m/s.

Outstanding characteristic is with stable performance and low noise, and the impeller is balanced according to G 2.5 to DIN ISO 1940/1. Inside of impeller the GG-hub is fixed with locked bush. The blade is made of stainless steel or steel.

### Inlet cone

The inlet cone is made of sheet steel and is a special part, it can lead air into impeller stably.

### Wrap part

Wrap part of Impeller and inlet cone is design to ensure impeller performance and take care to protect, this wrap part manufacture with aerodynamic via special testing.

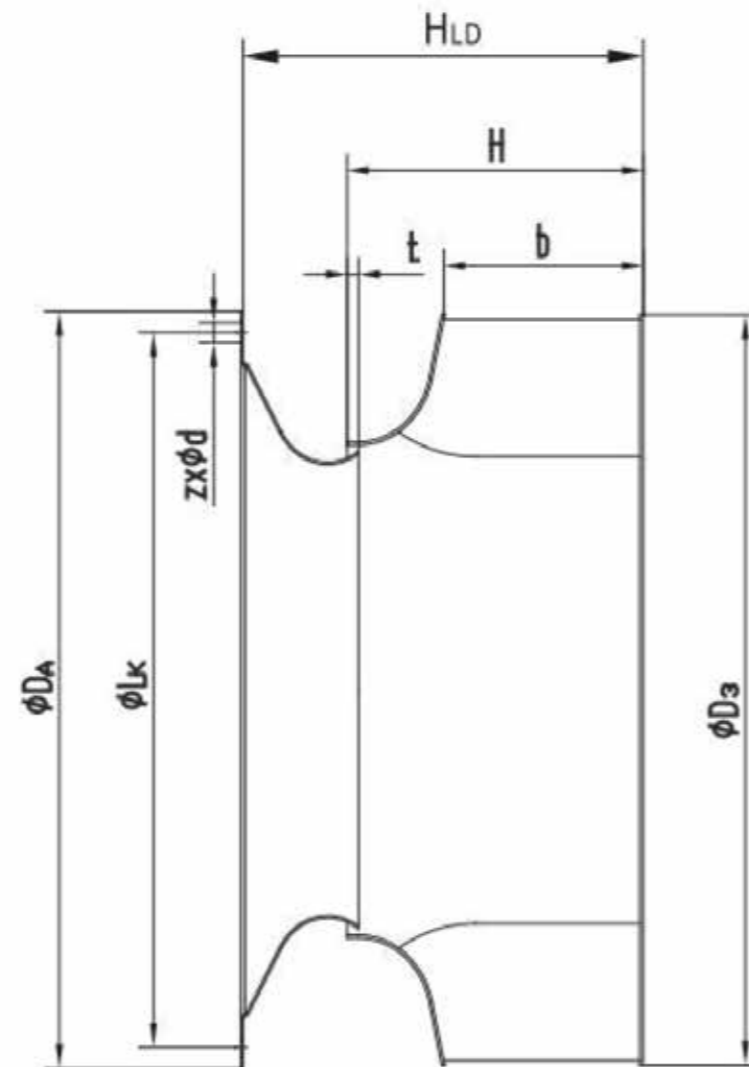

## PLUG FAN-RLM Series

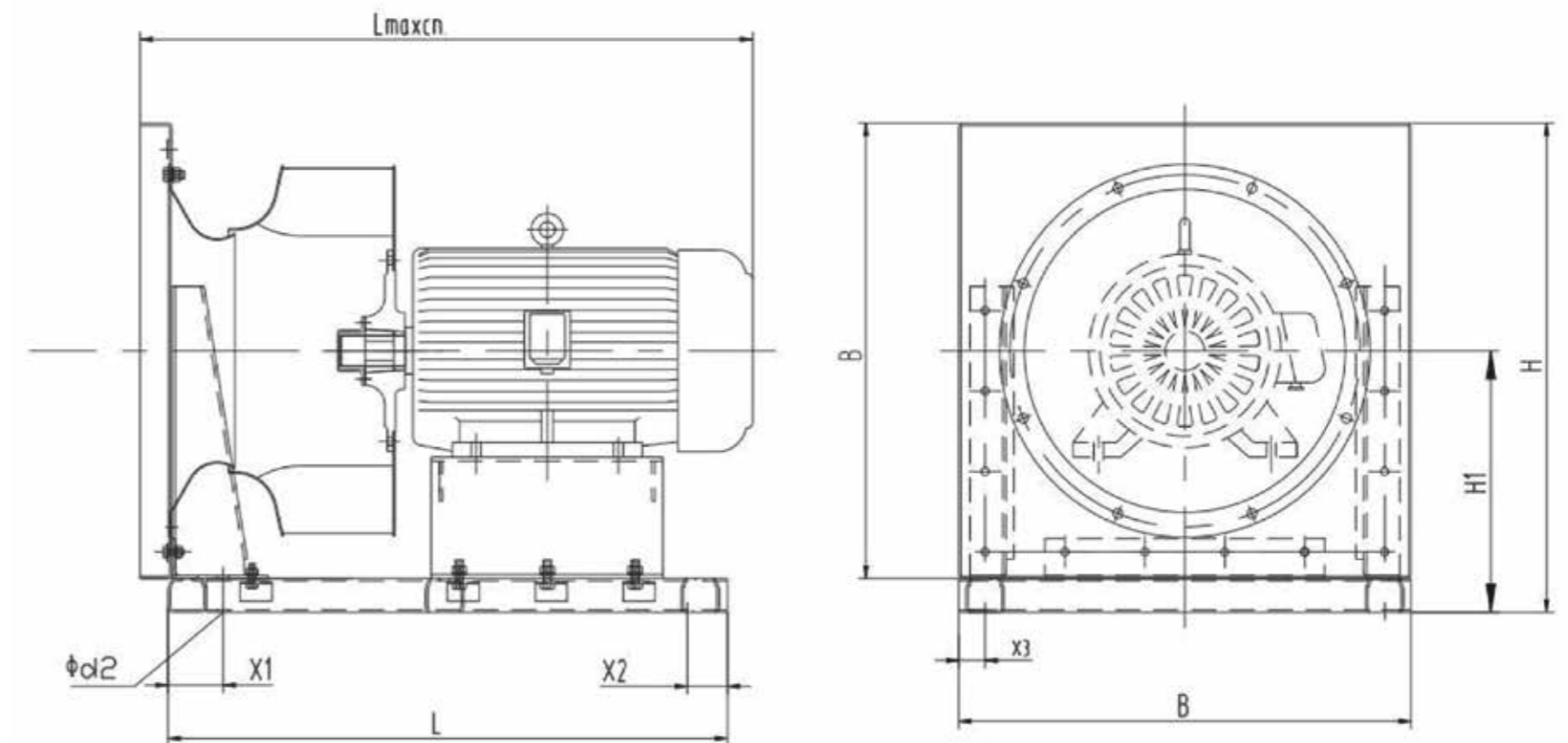

### Technical Specifications

Model	φD3	b	H	φDA	φLK	Zxφd	HLD	t	n <sub>max</sub>
250	257	80	118	280	259	6×7	158	5	4500
280	289	89	133	307	286	6×7	179.5	5.5	4300
315	324	100	146	348	320	6×7	200.5	5	4000
355	365	112	162	382	356	6×9	223.5	6	3500
400	410	126	185	422	395	8×9	253	7	2900
450	460	142	210	464	438	8×12	282	8	2900
500	517	159	235	515	487	8×12	317	8	2500
560	578	178	262	564	541	8×12	357	9	2200
630	648	199	293	638	605	8×12	401.5	10	1900
710	728	224	328	710	674	8×14	450	12	1600
800	818	252	368	785	751	8×14	506.5	14	1400
900	917	282	413	875	837	8×14	563.5	16	1250
1000	1012	316	462	970	934	8×14	629	18	960

### Technical Specifications

Model	B	H	H1	L	Lmaxca.	X1	X2	X3	φd2
250	376	414	226	475	610	60	40	24.5	14
280	400	438	238	475	610	60	40	24.5	14
315	430	468	253	520	660	60	40	24.5	14
355	462	500	269	533	680	60	40	25	14
400	502	540	289	586	740	60	40	25	14
450	566	608	325	700	780	69	50	33	14
500	612	654	348	760	800	80	50	31	14
560	688	744	400	870	950	100	50	38	18
630	768	824	440	920	990	100	50	39	18
710	850	935	510	1000	1090	100	50	50	18
800	940	1020	550	1100	1220	100	100	50	20
900	1044	1154	632	1200	1291	100	100	60	20
1000	1140	1250	680	1320	1486	100	100	60	20

# RLM-250

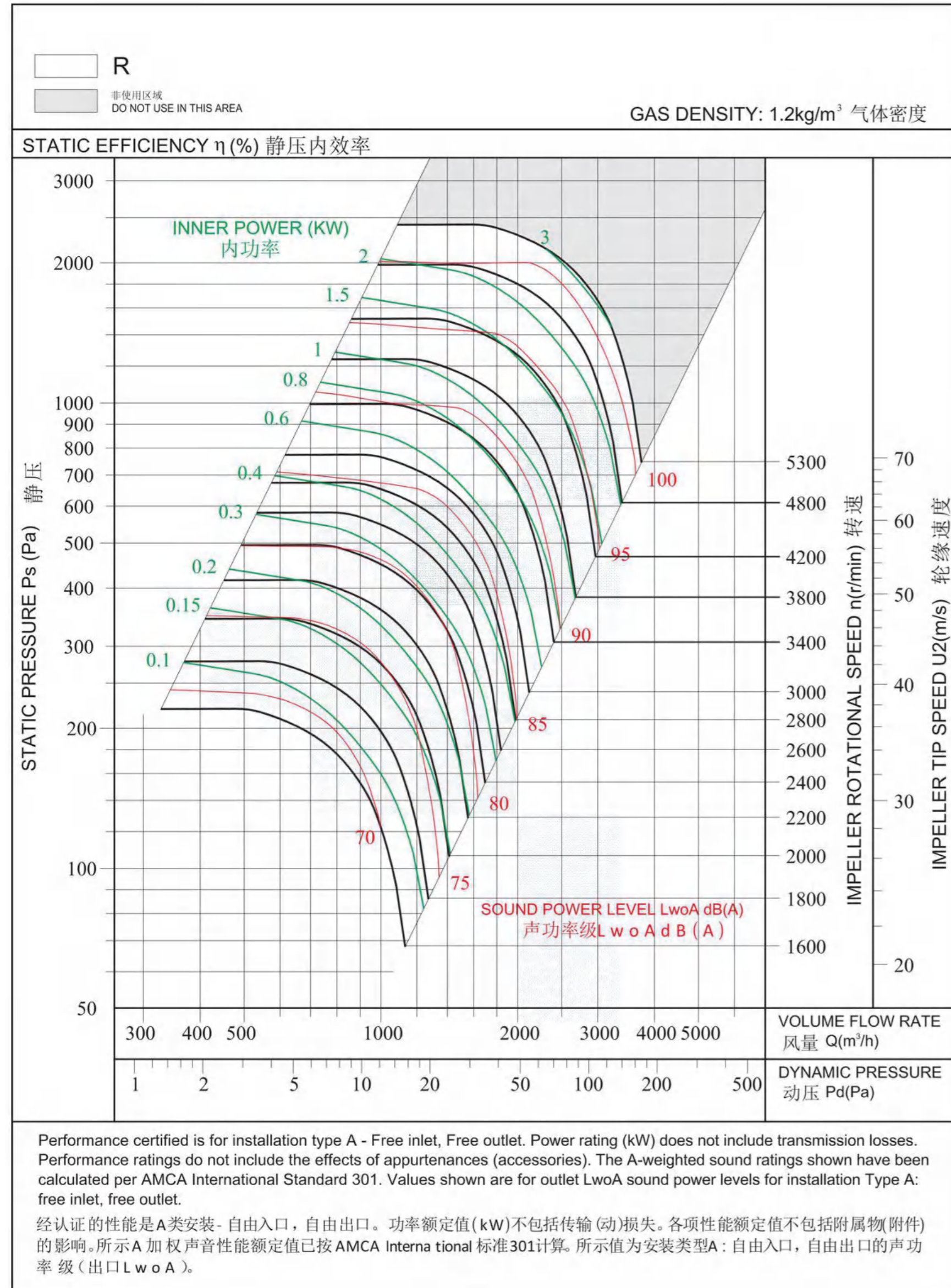

# RLM-280

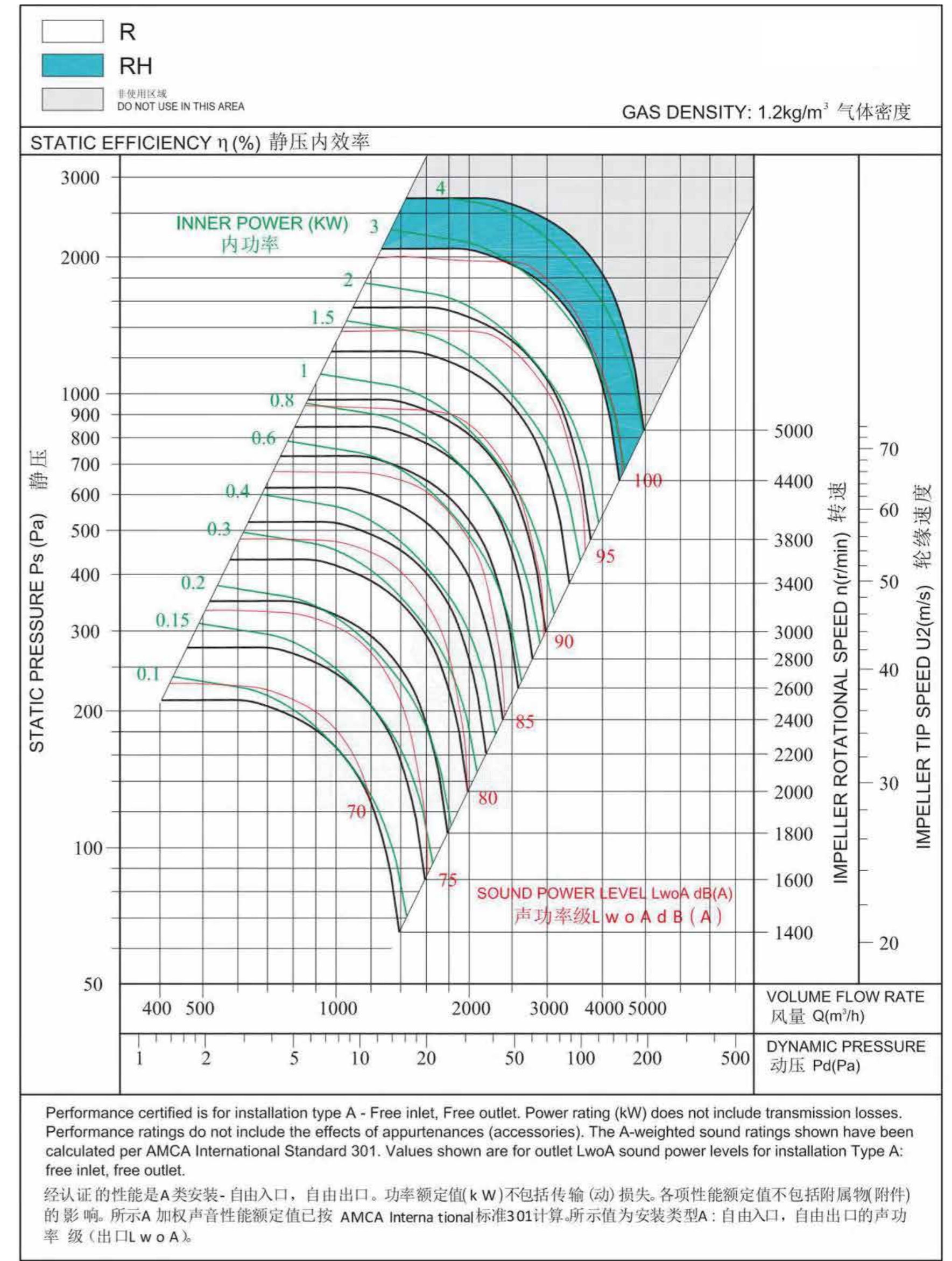

# RLM-315

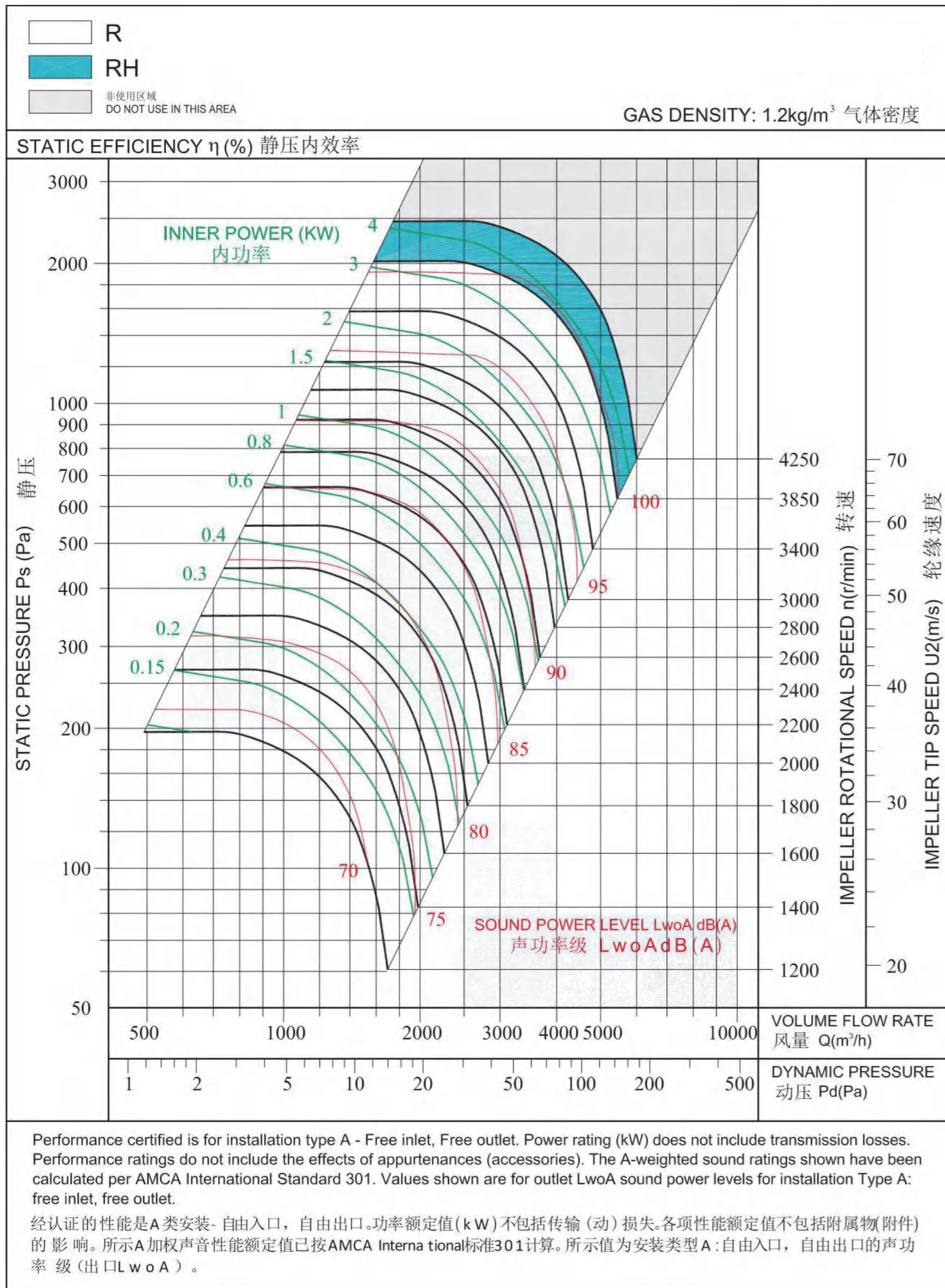

# RLM-355

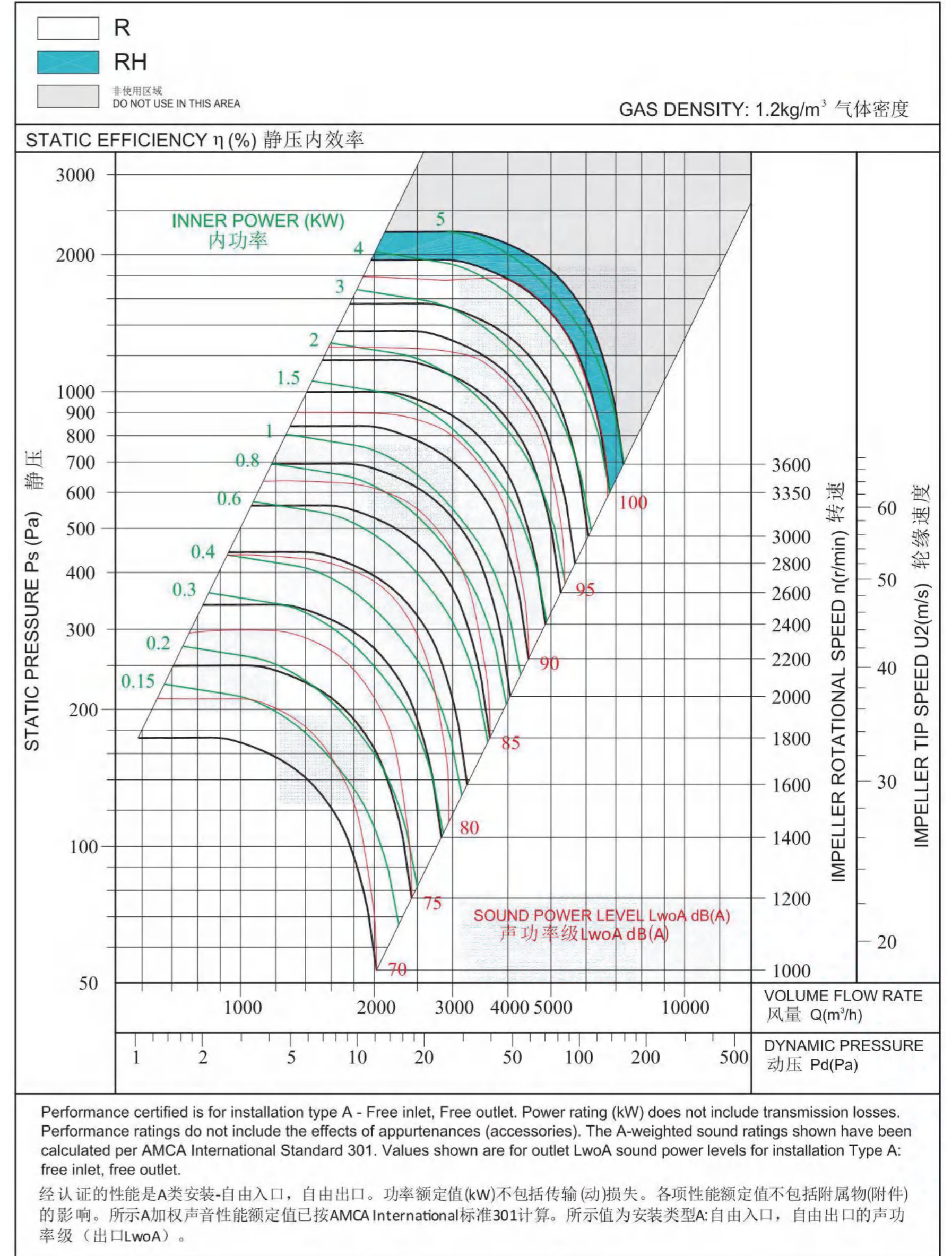

# RLM-400

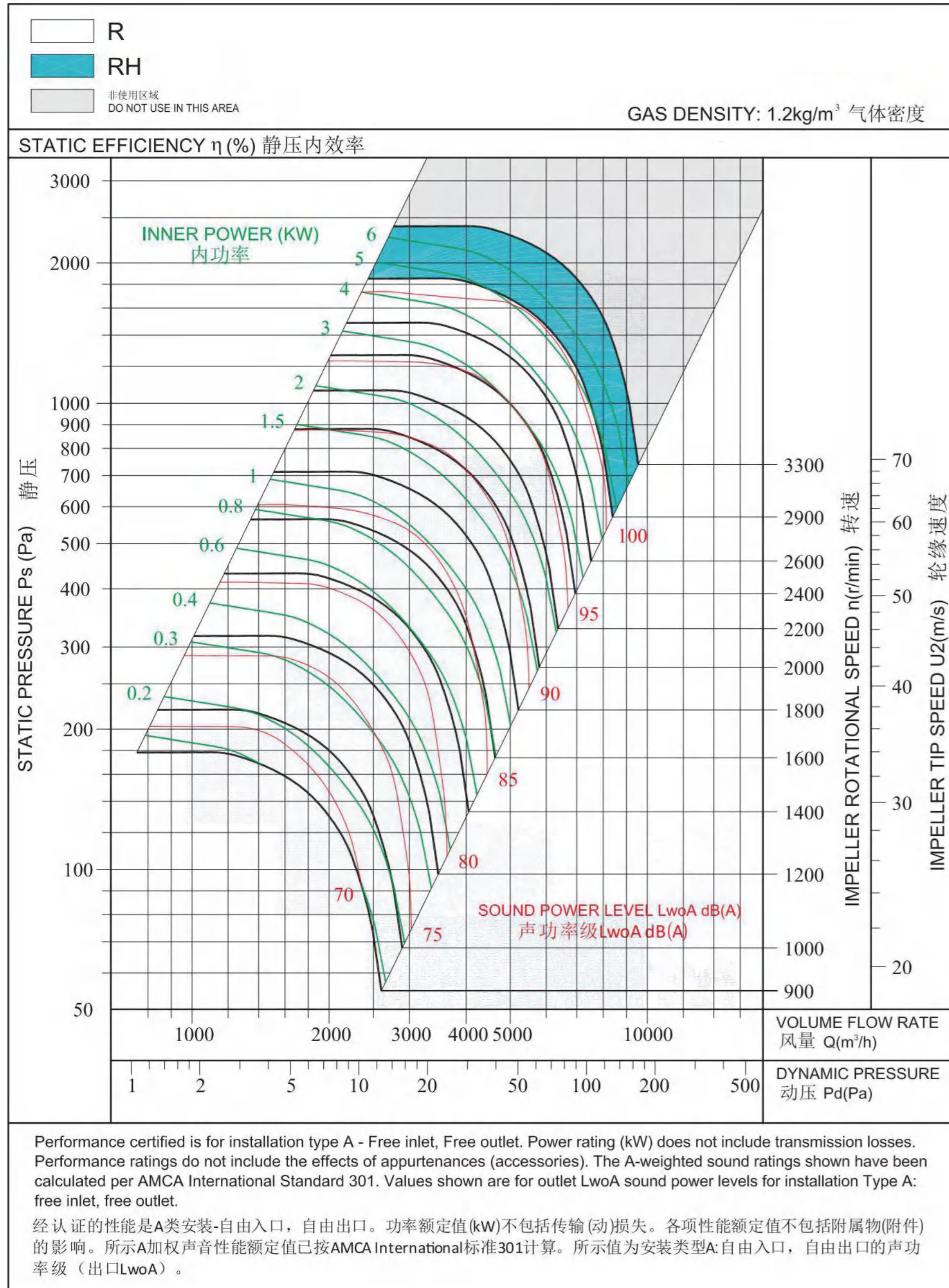

# RLM-450

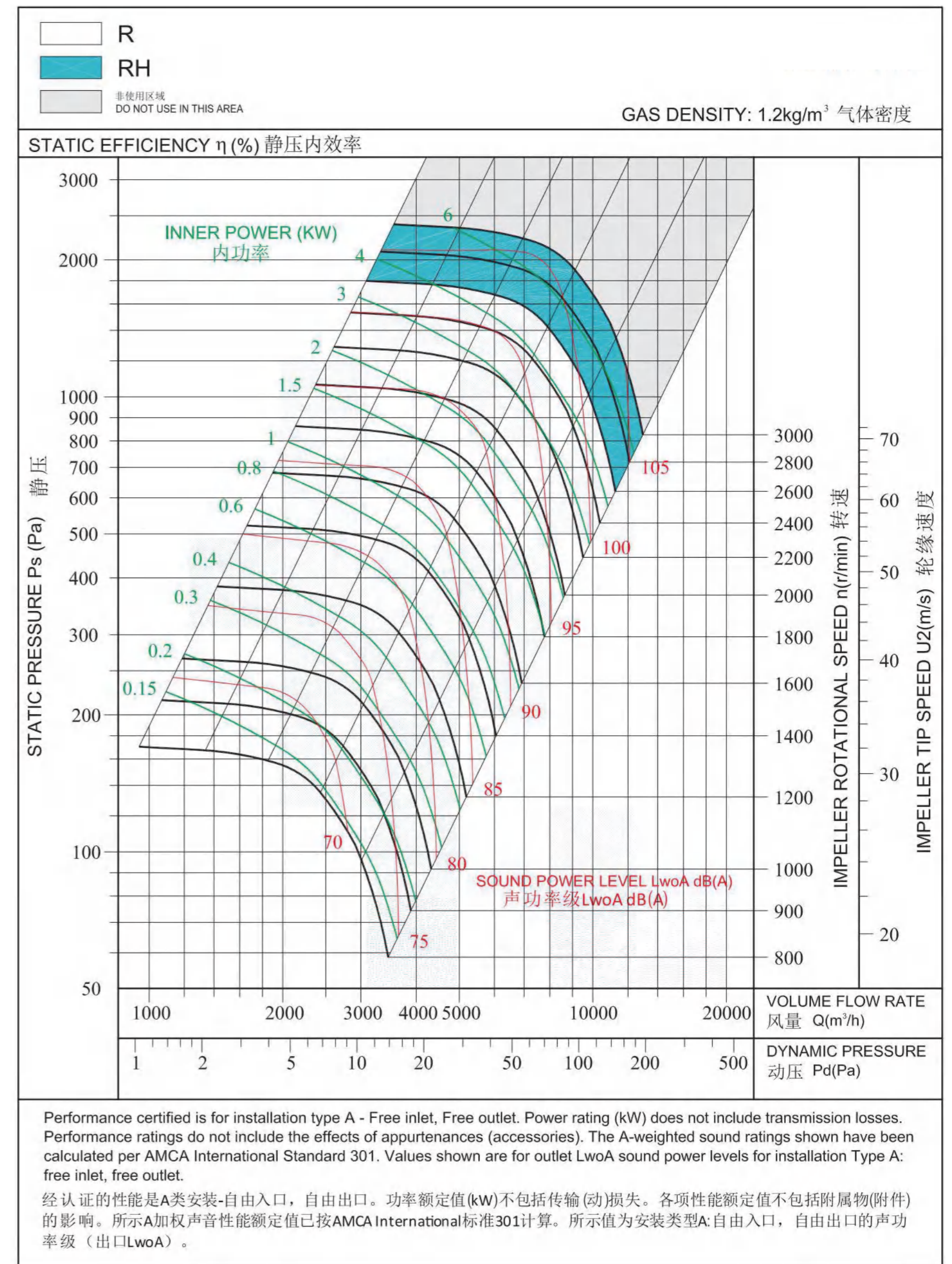

# RLM-500

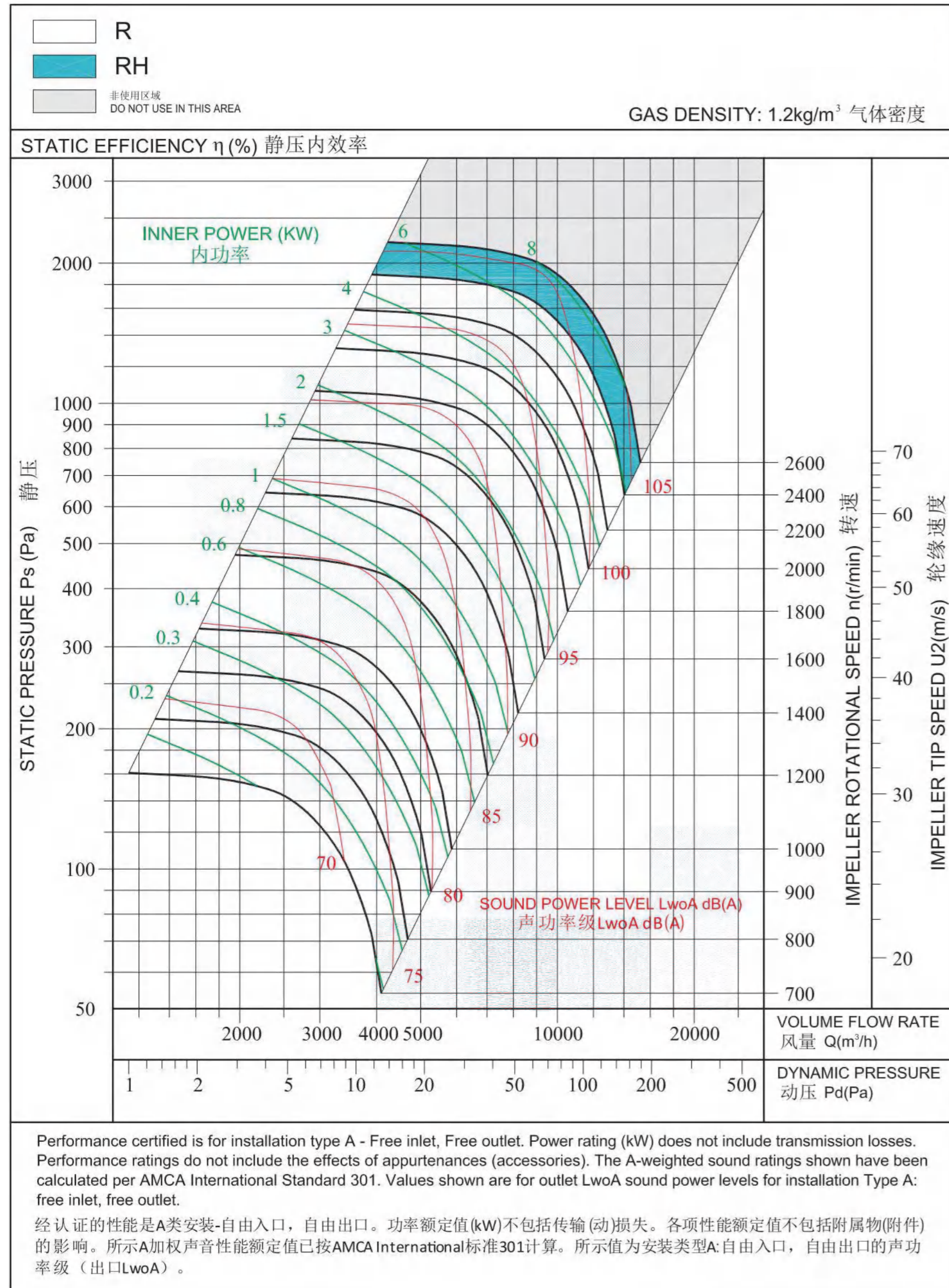

# RLM-560

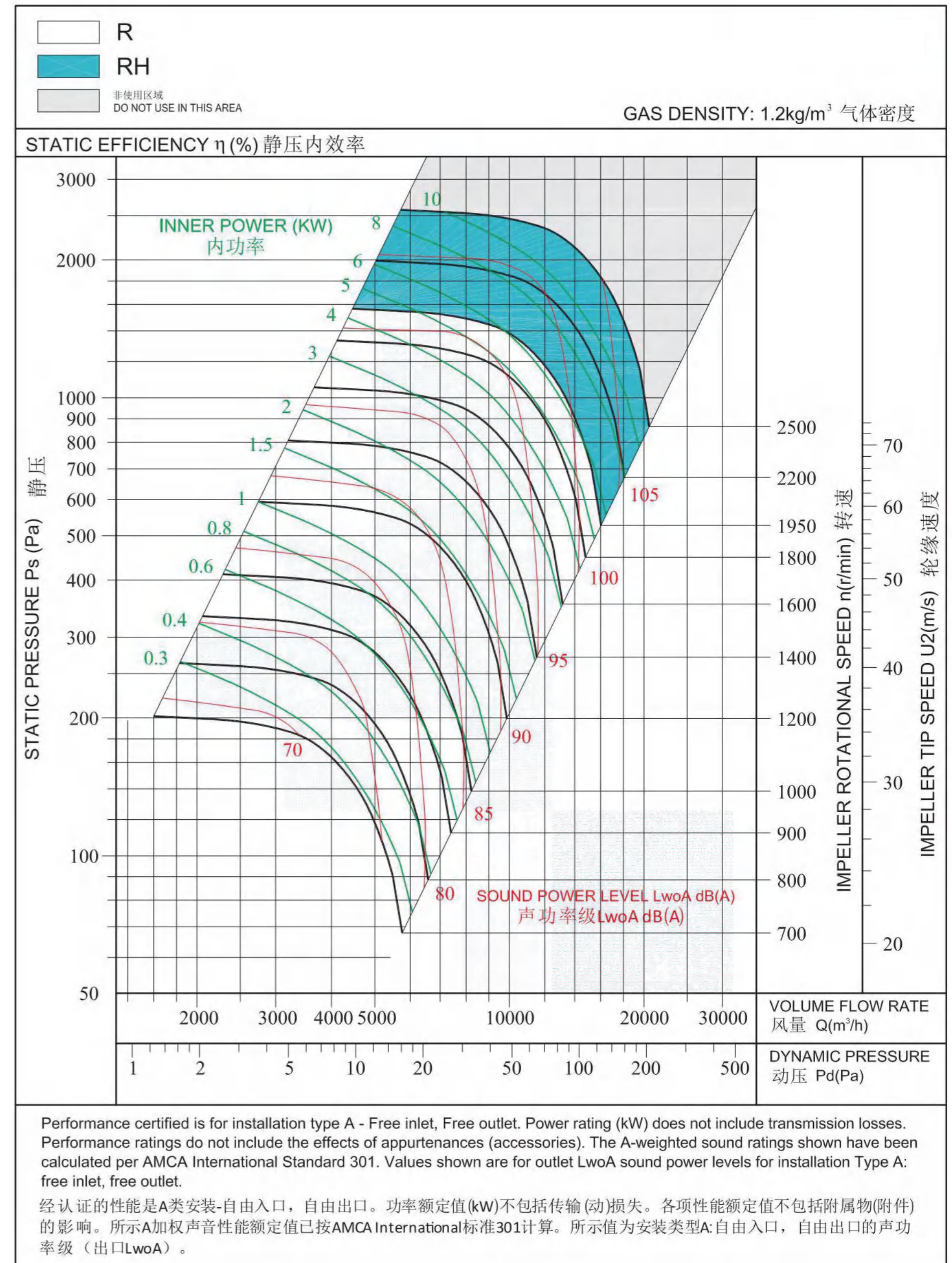

# RLM-630

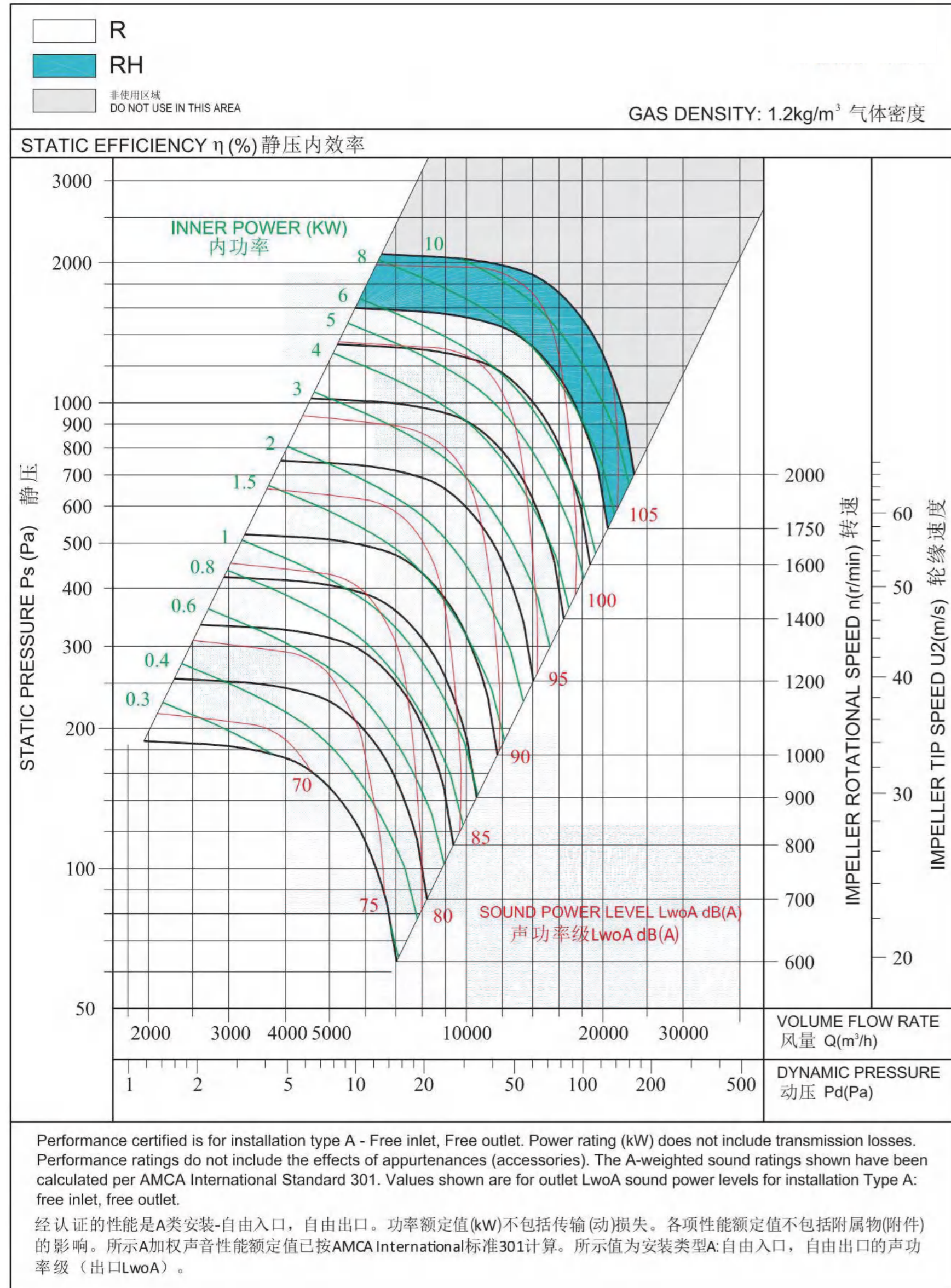

# RLM-710

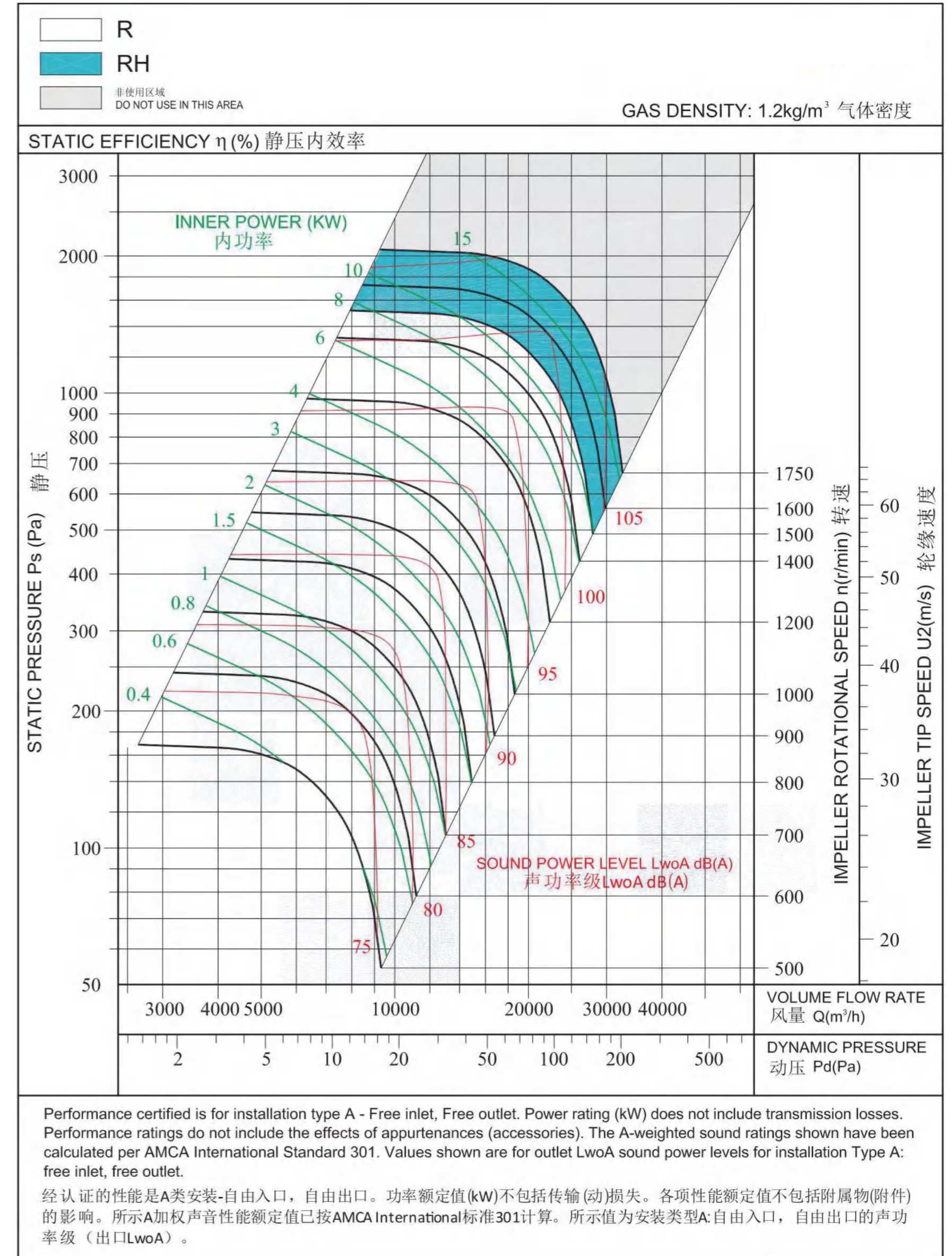

# RLM-800

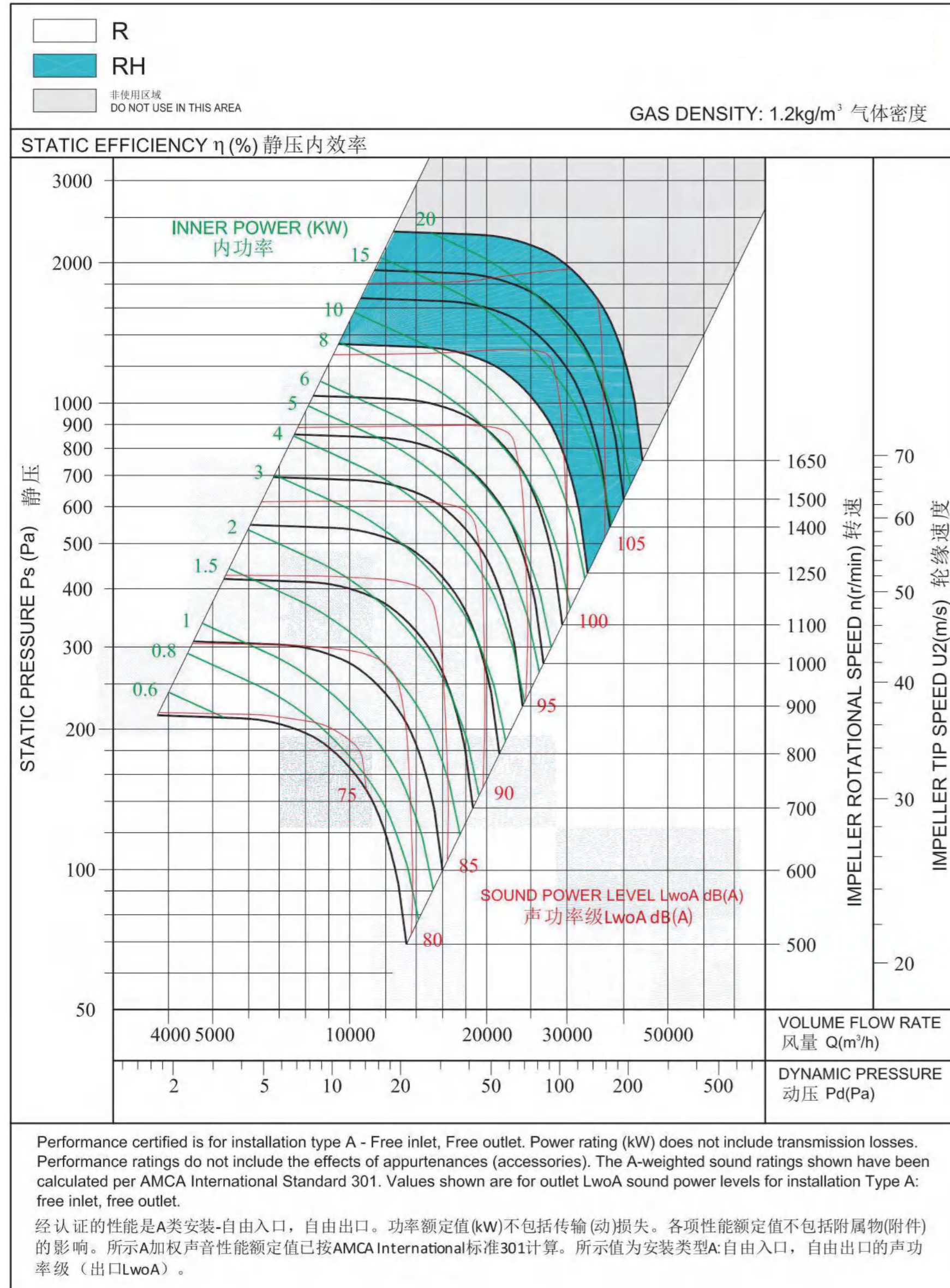

# RLM-900

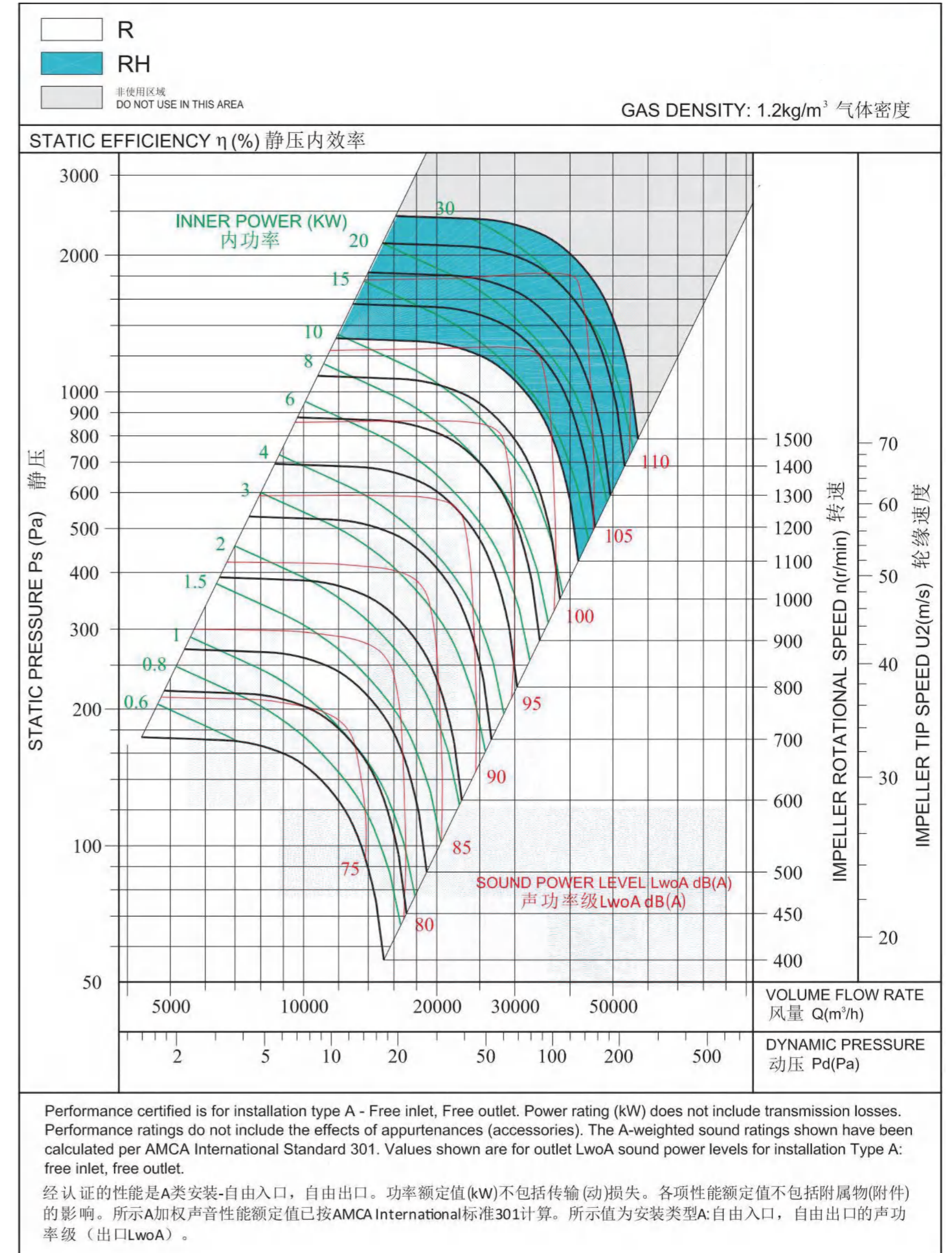

# RLM-1000

